

WTP-8B66 Series

User's Manual

Version V1.7

Copyright © 2017, ALL RIGHTS RESERVED.

All other brand names are registered trademarks of their respective owner

Copyright Notice
Copyright © 2017
All Rights Reserved.
Printed in Taiwan.

The information contained in this document is subject to change without any notices.

Acknowledgments

Greeting & Setup

Thank you for purchasing the WTP-8B66 Panel PC. We wish that this unit will be durable and reliable in providing your needs. Please follow the instructions below to ensure the unit continues to have high performance

Unpacking

After opening the carton, there will be a unit with an accessory box. Examine the contents to see if there are damages to the unit and if all accessories are present.

Setting up

Please read this manual carefully and remember to keep this manual for future reference.

Safety Instructions & Cleaning

The unit has undergone various tests in order to comply with safety standards. Inappropriate use may be dangerous. Please remember to follow the instructions below to insure your safety during the installation and operating process.

Transporting & Placement of unit

1. When moving the unit on a cart; be very cautious. Quick stops, excessive forces and uneven surfaces may cause the cart to overturn thus risking the unit to fall to the ground.
2. If the Monitor display unit does fall to the ground, immediately turn the power off and disconnect cords. Then contact a service technician for repairs. Continual use of the unit may result cause a fire or electric shock. Also, do not repair the unit on your own.
3. Having two or more people transporting the display unit is recommended. In addition, when installing the open frame by suspending it also requires two or more people.
4. Before suspending the unit, make sure the material used for suspension is sturdy and stable. If not properly suspended, the display unit may fall and cause serious injury to people standing nearby as well as to the unit itself.
5. If you wish to mount the display unit, remember to use only the mounting hardware recommended by the manufacturer.

Electrical and Power Source Related

1. This Monitor display unit must operate on a power source as shown on the specification label. If you are not sure what type of power supply used in the area, consult your dealer or local power supplier.
2. The power cords must not be damaged. Applied pressure, added heat, and tugging may damage the power cord.
3. The power cord must be routed properly when setup takes place. We advise that this aspect measure is to prevent people from stepping on the cords or while the unit is suspended to prevent flying objects from getting tangled with the unit.
4. Do not overload the AC outlets or extension cords. Electrical shocks or fires may occur from overloading.
5. Do not touch the power source during a thunderstorm.
6. If your hands are wet, do not touch the plug.
7. Use your thumb and index finger, grip firmly on the power cord to disconnect from the electrical socket. By pulling the power cord, may result in damaging it.

8. If the unit is not going to be in use for an extended period of time, remember to disconnect the unit.
9. Connect the unit to a power source with the same numerical value as spec. label shown. Please use only the power cord provided by the dealer to ensure safety and EMC compliance.

Various Factors of Environment

1. Do not insert objects into the openings.
2. Do not have liquids seep into the internal areas of the Monitor display unit.
3. Having liquids seep in or inserting objects into the unit may result in electric shocks from taking and/or short circuiting the internal parts.
4. Do not place the Monitor display unit in the presence of high moisture areas.
5. Do not install the Monitor display unit in a wet environment.
6. Do not place near unit near heat generating sources.
7. Do not place the unit in a location where it will come in contact with fumes or steam.
8. Remember to keep the Monitor display unit away from the presence of dust.
9. If water has flow in or seep in, immediately disconnect the open frame unit. Then contact a service technician for repairs.

Ventilation Spacing

1. Do not cover or block the openings on the top and back sides of the display unit. Inadequate ventilation may cause overheating thus reducing the lifespan of the unit.
2. Unless proper ventilation is present, do not place unit in an enclosed area; such as a built-in shelf. Keep a minimum distance of 10 cm between the display unit and wall.

Cleaning the unit

1. Remember to turn off the power source and to unplug the cord from the outlet before cleaning the unit.
2. Carefully dismount the unit or bring the unit down from suspension to clean.
3. Use only a dry soft cloth or clean room wiper when cleaning the LCD panel or touch screen surface. Use a soft cloth moistened with mild detergent to clean the display housing.
4. Remember to avoid having liquids seep into the internal components.

Servicing, Repairing, Maintenance & Safety Checks

1. If the unit is not functioning properly, observe the performance level of the display closely to determine what type of servicing is needed.
2. Do not attempt to repair the Monitor display unit on your own. Disassembling the cover exposes users' to high voltages and other dangerous conditions. Notify and request a qualified service technician for servicing the unit.
3. If any of the following situations occur turn the power source off and unplug the unit. Then contact a qualified service technician
 - i. A liquid was spilled on the unit or objects have fallen into the unit.
 - ii. The unit is soaked with liquids.
 - iii. The unit is dropped or damaged.
 - iv. If smoke or strange odor is flowing out of the open frame unit.
 - v. If the power cord or plug is damaged.
 - vi. When the functions of the unit are dysfunctional.

4. When part replacement is needed. Make sure service technician uses replacement parts specified by the manufacturer, or those with the same characteristics and performance as the original parts. If unauthorized parts are used it may result in starting a fire, electrical shock and/or other dangers.

Battery Installation

Follow below instructions and notice the caution for replacing and disposing of the RTC Lithium battery CR2032 for safety consideration.

CAUTION:

There is danger of explosion, if battery is incorrectly replaced. Replace only with the same or equivalent type recommended by the manufacturer. Dispose of used batteries according to the manufacturer's instruction.

WEEE information



For EU (European Union) member users: According to the WEEE (Waste Electrical and Electronic Equipment) Directive, do not dispose of this product as household waste or commercial waste. Waste electrical and electronic equipment should be appropriately collected and recycled as required by practices established for your country. For information on recycling of this product, please contact your local authorities, your household waste disposal service or the shop where you purchased the product.

The specification is subject to change without notice.

Version Change History

Date	Version	Description	Remark
2014/12/29	V1.0	First release	Ivy
2015/04/15	V1.1	Update touch stylus	Ivy
2015/07/15	V1.2	Remove reset button information	Ivy
2015/12/01	V1.3	<ul style="list-style-type: none">● Add wall mount and table stand assemble information	Ivy
2016/05/24	V1.4	Add Cautions : Continuous displaying fixed pattern may induce image sticking. It's recommended to use screen saver or moving content periodically if fixed pattern is displayed on the screen.	Eddie
2016/12/23	V1.5	Add option/customization information and touch lock AP user's manual.	Ivy
2017/07/13	V1.6	WEEE Information	Ivy
2017/08/16	V1.7	Add 8B66-22 information	Ivy

How to Use This Manual	1
System Overview	2
Table Stand Assemble Instruction	16
Wall Mount Stand Assemble Instruction.....	18
System View	20
Setting up the System.....	22
Installing System Software	23
Installing the Drivers.....	23
BIOS Setup Information.....	25
Appendix	33
A. Jumper settings and Connectors	33
B. Touch Lock AP User's Manual.....	49

How to Use This Manual

This manual is written for the system integrator, PC technician and knowledgeable PC end user. It describes how to configure your WTP-8B66 Panel PC to meet various operating requirements. The user's manual is divided into three chapters, with each chapter addressing a basic concept and operation of the server board.

Chapter 1: System Overview - presents what you have inside the box and gives you an overview of the product specifications and basic system architecture for the WTP-8B66 Panel PC.

Chapter 2: System Installation - describes how to set up the system.

Chapter 3: BIOS Setup Information - specifies the meaning of each setup parameter, how to get advanced BIOS performance and update to a new BIOS. Additionally, the POST checkpoint list will give you a guide for troubleshooting.

The contents of this manual are subject to change without prior notice. These changes will be incorporated in new editions of this manual.

Touch Chemical Resistance

Chemical Resistance

The active area of the touchscreen is resistant to the following chemicals when exposed for a period of one hour at a temperature of 70°F (21°C) :

- **Industrial Chemicals:** Acetone, Methylene chloride, Methyl ethyl ketone, Isopropyl alcohol, Hexane, Turpentine, Mineral spirits, Unleaded Gasoline, Diesel Fuel, Motor Oil, Transmission Fluid, Antifreeze.
 - **Food Service Chemicals:** Ammonia based glass cleaner, Laundry Detergents, Cleaners (Fantastic, Formula 409, Joy, etc.), Vinegar, Coffee, Tea, Grease, Cooking Oil, Salt.
-

System Overview

WTP-8B66- 15

System

CPU	Intel® Celeron® J1900 2.0 GHz quad-core processor 10W	
Graphic	Intel® HD Graphics	
Audio	Realtek ALC262 Audio Codec, 2+2 watts power amplifier	
LAN	Intel I210-AT Gigabit Ethernet x 2	
Memory	Dual Channel, two DDR3 SODIMM socket support up to 8GB	
Serial ATA	SATA II controller (3.0Gb/sec) Port x 2	
Serial port	External RS232/RS422/RS485 x 1(BIOS 設定, RS485 auto flow), RS232 x 1 Internal RS232 x 1 RS232 (Jumper 5V, 12V) x1	
USB	External	USB 2.0 type a x 4
	Internal	Mini-PCIE x 2(default) or USB 2.0 pinhead x 2(option) Touch x 1 Pin head X 2
WDT	Generates system reset; 256 segments, 0, 1, 2...25	

BIOS

Brand: AMI

Flash ROM size: 64MB

Support RTC wakeup /Wake on LAN /Power on after power failure/PnP/AC PI/RTC

**com port have to be disabled if PXE enable. It is a limitation

- Press F11 to Quick boot menu.
Select First LAN port for PXE boot.

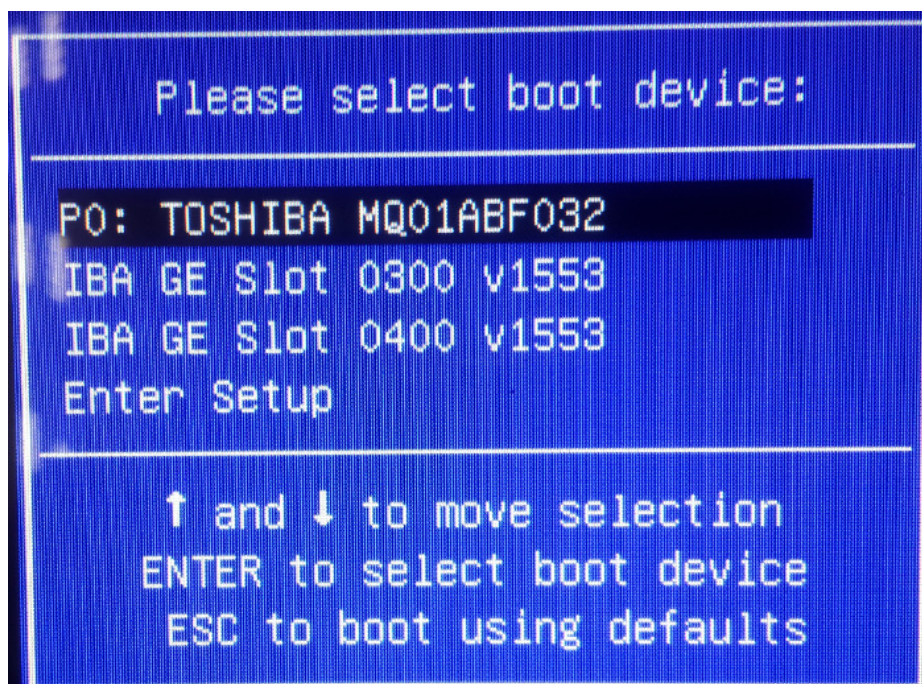

Display

Brand	Tianma
Resolution (pixel)	1024x768 XGA
Active Area (mm)	304.128 (W) x 228.096 (V)
Outline Dimensions (mm)	326.5 (H) x 253.5 (V) x 11.8
Pixel Pitch (mm)	0.297
Mode	TN
Number of Colors	16.7M
View Angle (H/V)	160/160
Brightness (cd/m²)	450
Contrast Ratio	600:1
Response Time (ms) (at 25°C)	8
Backlight	LED
Weight (g)	1000
life time<Hrs>	50000

Cautions:

Continuous displaying fixed pattern may induce image sticking. It's recommended to use screen saver or moving content periodically if fixed pattern is displayed on the screen.

Touch Screen

	ELO
Type	5 wire RES
Glove	Any type glove
Input mode	Point: Finger or touch pen Drag: Finger
Interface	USB
Light Transmission	80±5%
Hardness	4H
Glass thickness	2.4mm
Linearity	X ≤ 1.5%, Y ≤ 1.5%
Active area	308.11x232.09mm
Resolution	4096x4096
Lifetime	35 million activations

Storage

2.5" SATA drive bay x 1

Expansion slots

Mini-PCIe x2

External water/dust resistant I/O (rear side)

USB	1 x M12 8pin for USB 1/2 1 x M12 8pin for USB 3/4
COM	1 x M12 8pin for COM 1/RS-232/422/485 (Default RS-232) 1 x M12 8pin for COM 2/RS-232
RS-232: TxD, RxD, RTS, CTS, DTR, DSR, DCD, GND	

LAN	1 x M12 8pin for LAN 1
Power	1 x M12 5pin DC power connector

Power

Power	DC-In connector x 1
Power Input	DC7V~32V
Power Adapter	AC 90 ~ 264V / 47 ~ 63 Hz / DC output 12V, IP67 Power ON/Off buttons at rear side
Power consumption	35w(full loading) 2.3w (S3)

Mechanical & Environmental

Material construction	SUS304 stainless steel enclosure, chassis type
Fanless cooling	
Water and dust protection	IP66 / NEMA4X
Operation Temperature	0~40℃ (IEC60068-2-2, HDD, air flow cooling)
Storage Temperature	-20~60℃
Operation Relative Humidity	10%~90%, non-condensing
Storage Relative Humidity	10%~90%, non-condensing
Dimensions	395x309.5x58
Net Weight	12.4kg
Gross Weight	8.4kg
Mounting	VESA (100x100 mmxmm), side mount (M6*2)

Supported OS

Win 7, Win 7 Pro, Win8.1, Win 10

Options

1. Wireless or WIFI and BT kit (2 ant)
2. Waterproof COM cable, cable length is 2 meters
3. Waterproof USB cable, cable length is 2 meters
4. Waterproof LAN cable, cable length is 2 meters
5. wall mount / table mount bracket (option)
6. SSD
7. 2 external LAN

Customization (by DRF)

1. sunlight readable optical bonding
2. full flat PCT touch screen IP69K
3. 1000 nit high brightness LCD
4. LCD Auto dimming
5. LCD Super dimming (low brightness)
6. Robust Antenna
7. 2W/5W speaker
8. IP67
9. COM+Power 5V/12V
10. USB3.0
11. SUS316 enclosure

Packing list

1. WTP-8B66-15
2. DVD-Title for driver and manual
3. Power adapter
4. Power cord

Regulatory

FCC, CE (EMC), VCCI class B

Shock/Vibration/Drop

	Shock	Vibration	Drop				
General	Operating: Pulse shape : Half-sine waveform Impact acceleration : 15g Pulse duration : 11 ms Number of shocks : 18 shocks (3 shock for	Operating: 5 ~ 500Hz , Acceleration : 1.0G Sweep time : 15 minutes Number of cycle : 1 cycle for each axis Vibration axes : X, Y and Z	According to ISTA Project 2A to determine a drop height in the following chart. (test surface: concrete, with packing) 6 surfaces				
			<table border="1"> <thead> <tr> <th>Package-product Weight</th> <th>Drop Height</th> </tr> </thead> <tbody> <tr> <td>21-40.99 lb (9.53-18.59kg)</td> <td>32 in. (0.813 m)</td> </tr> </tbody> </table>	Package-product Weight	Drop Height	21-40.99 lb (9.53-18.59kg)	32 in. (0.813 m)
	Package-product Weight	Drop Height					
21-40.99 lb (9.53-18.59kg)	32 in. (0.813 m)						

	each \pm axis) Orientation : \pm X , $\pm Y$ and $\pm Z$ axes		
--	--	--	--

Configurations:

1. WTP-8B66-15, Celeron J1900 CPU, 2G RAM, 500G HDD, 4 USB, 2 COM, 1 LAN

WTP-8B66-19

System

CPU Intel® Celeron® J1900 2.0 GHz quad-core processor 10W

Graphic Intel® HD Graphics

Audio Realtek ALC262 Audio Codec, 2+2 watts power amplifier

LAN Intel I210-AT Gigabit Ethernet x 2

Memory Dual Channel, two DDR3 SODIMM socket support up to 8GB

Serial ATA SATA II controller (3.0Gb/sec) Port x 2

Serial port External RS232/RS422/RS485 x 1(BIOS 設定, RS485 auto flow), RS232 x 1
Internal RS232 x 1

RS232 (Jumper 5V, 12V) x1

USB External USB 2.0 type a x 4

Internal Mini-PCIE x 2(default) or USB 2.0 pinhead x 2(option)

Touch x 1

Pin head X 2

WDT Generates system reset; 256 segments, 0, 1, 2...25

BIOS

Brand: AMI

Flash ROM size: 64MB

Support RTC wakeup /Wake on LAN /Power on after power failure/PnP/AC PI/RTC

**com port have to be disabled if PXE enable. It is a limitation

- Press F11 to Quick boot menu.
Select First LAN port for PXE boot.

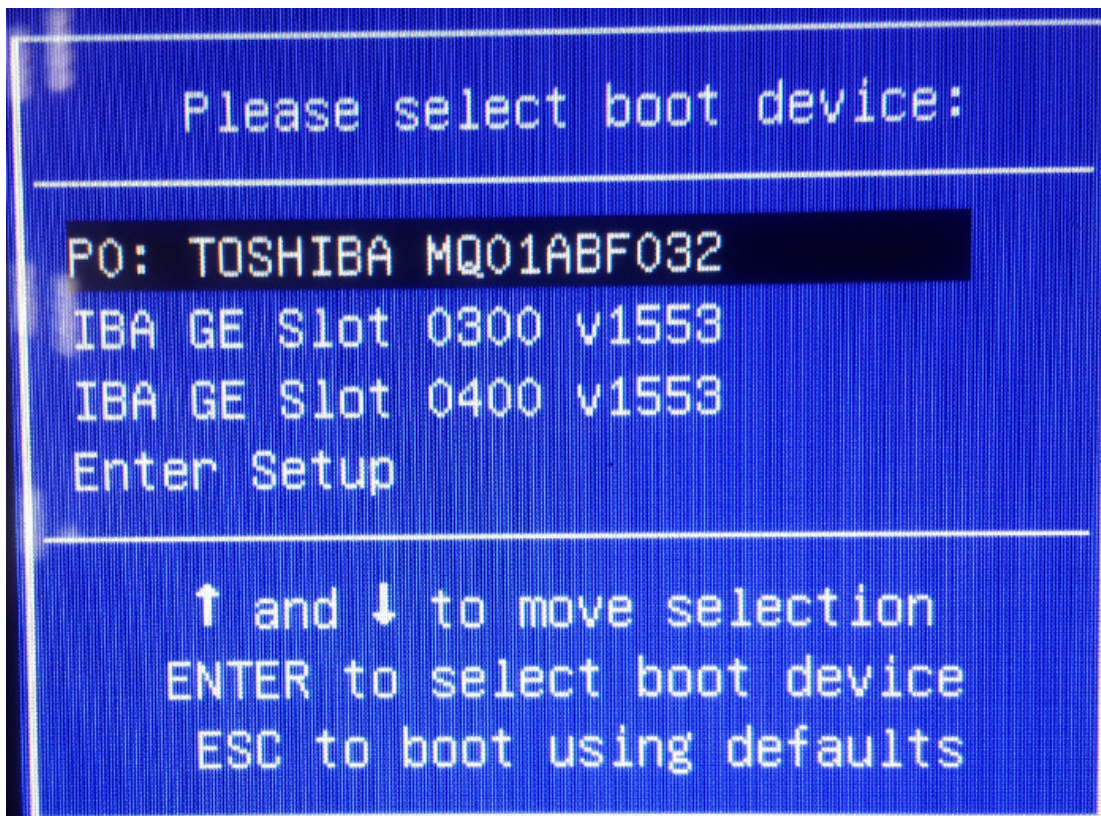

Display

Brand	AUO
Resolution (pixel)	SXGA 1280(x3) x 1024
Active Area (mm)	376.32 (H) x 301.06(V)
Number of Colors	16.7M
View Angle (H/V)	170 / 160
Brightness (cd/m2)	350
Contrast Ratio	1000:1
Response Time (ms) (at 25°C)	5
Backlight	LED
Weight (g)	1670
life time<Hrs>	50000

Touch Screen

	ELO
Type	5 wire RES
Glove	Any type glove
Input mode	Point: Finger or touch pen Drag: Finger
Interface	USB
Light Transmission	80±5%
Hardness	4H
Glass thickness	2.4mm
Linearity	$X \leq 1.5\%$, $Y \leq 1.5\%$
Active area	308.11x232.09mm
Resolution	4096x4096
Lifetime	36 million activations

Storage

2.5" SATA drive bay x 1

Expansion slots

Mini-PCIe x2

External water/dust resistant I/O (rear side)

USB 1 x M12 8pin for USB 1/2

1 x M12 8pin for USB 3/4

COM 1 x M12 8pin for COM 1/RS-232

1 x M12 8pin for COM 2/RS-232

RS-232: TxD, RxD, RTS, CTS, DTR, DSR, DCD, GND

LAN 1 x M12 8pin for LAN 1
Power 1 x M12 5pin DC power connector

Power

Power DC-In connector x 1
Power Input DC7V~32V
Power Adapter AC 90 ~ 264V / 47 ~ 63 Hz / DC output 12V,
Power ON/Off buttons at rear side
Power consumption 40.7w(full loading) 2.0w (S3)

Mechanical & Environmental

Material construction SUS304 stainless steel enclosure, chassis type
Fanless cooling
Water and dust protection IP66 / NEMA4X
Operation Temperature 0~40℃ (IEC60068-2-2, HDD, air flow cooling)
Storage Temperature -20~60℃
Operation Relative Humidity 10%~90%, non-condensing
Storage Relative Humidity 10%~90%, non-condensing
Dimensions 458x386x64
Net Weight 11.5kg
Gross Weight 15kg
Mounting VESA (100x100 mmxmm) side mount (M6*2)

Supported OS

Win 7, Win 7 Pro, Win8.1, Win10

Options

1. Wireless or Wireless and BT kit (2 ant)
2. Waterproof COM cable, cable length is 2 meters
3. Waterproof USB cable, cable length is 2 meters
4. Waterproof LAN cable, cable length is 2 meters
5. wall mount / table mount bracket (option)
6. SSD
7. 2 external LAN

Customization (by DRF)

1. sunlight readable optical bonding
2. full flat PCT touch screen IP69K
3. 1000 nit high brightness LCD
4. LCD Auto dimming
5. LCD Super dimming (low brightness)

- 6. 2W/5W Speaker
- 7. Robust Antenna
- 8. IP67
- 9. COM+Power 5V/12V
- 10. USB3.0
- 11. SUS316 enclosure

Packing list

- 12. WTP-8B66-19
- 13. DVD-Title for driver and manual
- 14. Power adapter
- 15. Power cord

Regulatory

FCC, CE (EMC), VCCI class B

Shock/Vibration/Drop

	Shock	Vibration	Drop	
General	Operating: Pulse shape : Half-sine waveform Impact acceleration : 15g Pulse duration : 11 ms Number of shocks : 18 shocks (3 shock for each \pm axis) Orientation : \pm X, \pm Y and \pm Z axes	Operating: 5 ~ 500Hz , Acceleration : 1.0G Sweep time : 15 minutes Number of cycle : 1 cycle for each axis Vibration axes : X, Y and Z	According to ISTA Project 2A to determine a drop height in the following chart. (test surface: concrete, with packing)6 surfaces	
			Packag e-produ ct Weight	Drop Height
			21-40.9 9 lb (9.53-1 8.59kg)	32 in. (0.813 m)

Configurations:

- 2. WTP-8B66-19, Celeron J1900 CPU, 2G RAM, 500G HDD, 4 USB, 2 COM, 1 LAN

WTP-8B66-22

Specifications

System

CPU	<i>Intel® Celeron® J1900 2.0 GHz quad-core processor 10W</i>	
Graphic	<i>Intel® HD Graphics</i>	
Audio	<i>Realtek ALC262 Audio Codec, 2+2 watts power amplifier</i>	
LAN	<i>Intel I210-AT Gigabit Ethernet x 2</i>	
Memory	<i>Dual Channel, two DDR3 SODIMM socket support up to 8GB DDR3L-1333</i>	
Serial ATA	<i>SATA II controller (3.0Gb/sec) Port x 2</i>	
Serial port	<i>External RS232/RS422/RS485 x 1(BIOS 設定, RS485 auto flow), RS232 x 1</i> <i>Internal RS232 x 1</i> <i>RS232 (Jumper 5V, 12V) x1</i>	
USB	<i>External</i>	<i>USB 2.0 type a x 4</i>
	<i>Internal</i>	<i>Mini-PCIE x 2(default) or USB 2.0 pinhead x 2(option)</i> <i>Touch x 1</i> <i>Pin head X 2</i>
WDT	<i>Generates system reset; 256 segments, 0, 1, 2...25</i>	

BIOS

Brand: AMI

Flash ROM size: 64MB

Support RTC wakeup /Wake on LAN /Power on after power failure/PnP/ACPI/RTC

- com port have to be disabled if PXE enable. It is a limitation
- Press F11 to Quick boot menu.
Select First LAN port for PXE boot.

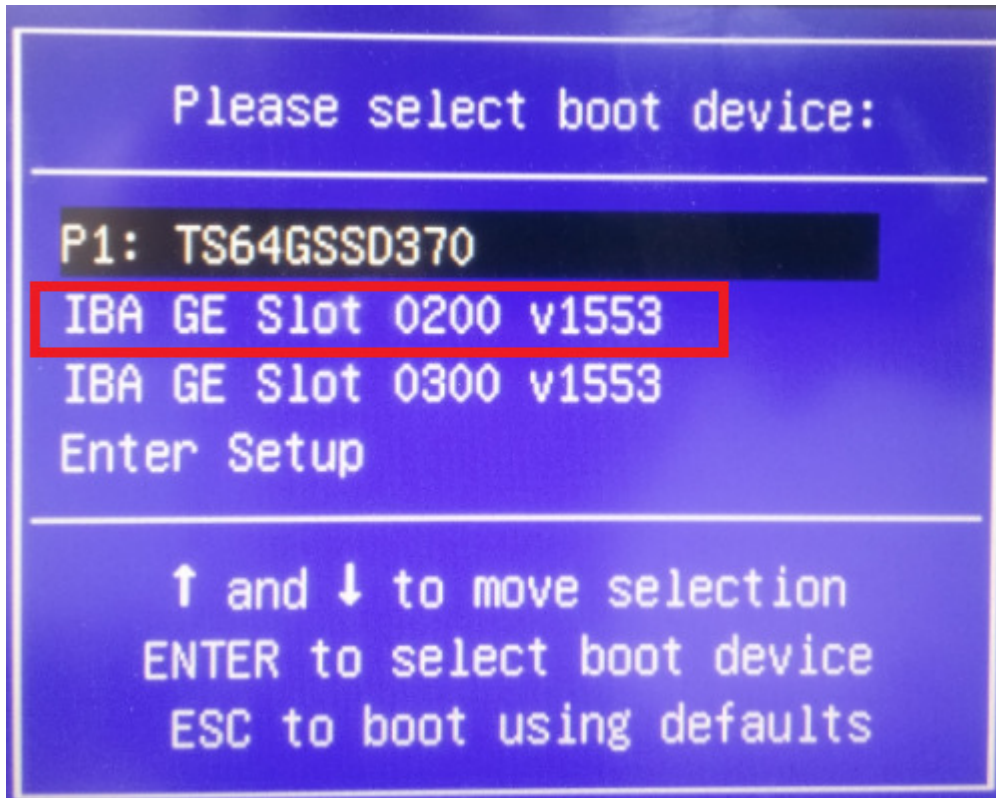

Display

Brand	AUO
Model	M215HTN01.1
Resolution (pixel)	1920 x 1080 (Full HD)
Active Area (mm)	476.64(H) x 268.11(V)
Number of Colors	16.7M
View Angle (H/V)	85 / 80
Brightness (cd/m2)	250
Contrast Ratio	1000:1
Response Time (ms) (at 25°C)	5
Backlight	LED
Weight (g)	1750
life time<Hrs>	30000

Touch Screen

	ELO
Model name	E387716
Type	5 wire RES
Glove	Any type glove
Stylus	No Limitation, can use any stylus
Interface	USB

<i>Light Transmission</i>	<i>80±5%</i>
<i>Hardness</i>	<i>4H</i>
<i>Glass thickness</i>	<i>2.4mm</i>
<i>Linearity</i>	<i>X ≤1.5%, Y ≤1.5%</i>
<i>Active area</i>	<i>480 x271.5mm</i>
<i>Lifetime</i>	<i>490,000 hours</i>

Storage

2.5" SATA drive bay x 1

Expansion slots

Mini-PCIe X 2

External water/dust resistant I/O (rear side)

USB 1 x M12 8pin for USB 1/2

1 x M12 8pin for USB 3/4

COM 1 x M12 8pin for COM 1/RS-232

1 x M12 8pin for COM 2/RS-232

RS-232: TxD, RxD, RTS, CTS, DTR, DSR, DCD, GND

LAN 1 x M12 8pin for LAN 1

Power 1 x M12 5pin DC power connector

Power

Power DC-In connector x 1

Power Input DC7V~32V

*Power Adapter AC 90 ~ 264V / 47 ~ 63 Hz / DC output 12V
IP67, 60W/12V/5A*

Power ON/Off buttons at rear side

Power consumption 40.2W

Mechanical & Environmental

Material construction SUS304 stainless steel enclosure, chassis type

Fanless cooling

Water and dust protection IP66 / NEMA4X

*Operation Temperature 12V DC Input 0~40 °C (IEC60068-2-56, air flow cooling)
32V DC Input 0~30 °C (IEC60068-2-56, air flow cooling)*

Storage Temperature -20~60 °C

Operation Relative Humidity 10%~90%, non-condensing

Storage Relative Humidity 10%~90%, non-condensing

Dimensions 557 x 348.5 x 58.5 mm

Net Weight 12KG
 Gross Weight 14KG
 Mounting VESA (100x100 mmxmm) side mount (M6*2)

Supported OS

Win 7, Win 7 Pro, Win8.1, Win 10

Options

1. Wireless or Wireless and BT kit (2 ant)
2. Waterproof COM cable, cable length is 2 meters
3. Waterproof USB cable, cable length is 2 meters
4. Waterproof LAN cable, cable length is 2 meters
5. wall mount / table mount bracket (option)
6. SSD
7. 2 external LAN
8. Robust Antenna

Customization (by DRF)

1. sunlight readable optical bonding
2. full flat PCT touch screen IP69K
3. 1000 nit high brightness LCD
4. LCD Auto dimming
5. LCD Super dimming (low brightness)
6. 2W/5W Speaker
7. IP67
8. Second HD
9. COM+Power 5V/12V
10. USB3.0
11. SUS316 enclosure

Packing list

1. WTP-8B66-22
2. DVD -Title for driver and manual
3. Power adapter
4. Power cord

Regulatory

FCC-B, CE (EMC), VCCI class B

Shock/Vibration/Drop

	Shock	Vibration	Drop
--	-------	-----------	------

General	<p><i>Operating:</i> <i>Pulse shape : Half-sine waveform</i> <i>Impact acceleration : 15g</i> <i>Pulse duration : 11 ms</i> <i>Number of shocks : 18 shocks (3 shock for each \pm axis)</i> <i>Orientation : $\pm X$, $\pm Y$ and $\pm Z$ axes</i></p>	<p><i>Operating:</i> <i>5 ~ 500Hz , Acceleration : 1.0G</i> <i>Sweep time : 15 minutes</i> <i>Number of cycle : 1 cycle for each axis</i> <i>Vibration axes : X, Y and Z</i></p>	<p>According to ISTA Project 2A to determine a drop height in the following chart. (test surface: concrete, with packing)6 surfaces</p>				
			<table border="1"> <thead> <tr> <th>Package-product Weight</th> <th>Drop Height</th> </tr> </thead> <tbody> <tr> <td>21-40.99 lb (9.53-18.59kg)</td> <td>32 in. (0.813 m)</td> </tr> </tbody> </table>	Package-product Weight	Drop Height	21-40.99 lb (9.53-18.59kg)	32 in. (0.813 m)
	Package-product Weight	Drop Height					
21-40.99 lb (9.53-18.59kg)	32 in. (0.813 m)						

Configurations:

WTP-8B66-22, J1900 2 GHz,2G RAM, 500G HDD, 4 USB, 2 COM, 1 LAN

Table Stand Assemble Instruction

Step 1. Please check out the following parts before assemble.

No.	Item	Quantity
1	Table Stand	1
2	Black Silicone Washer	2
3	Black Handle	2

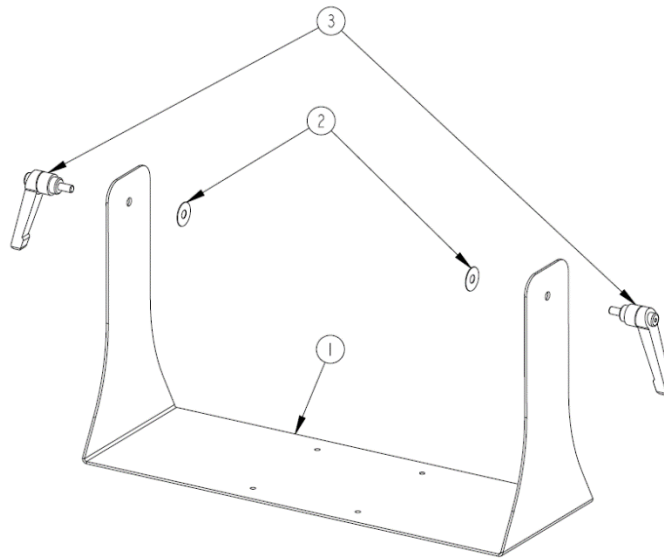

Step 2. Please follow the picture diagrams to assemble.

Explode View

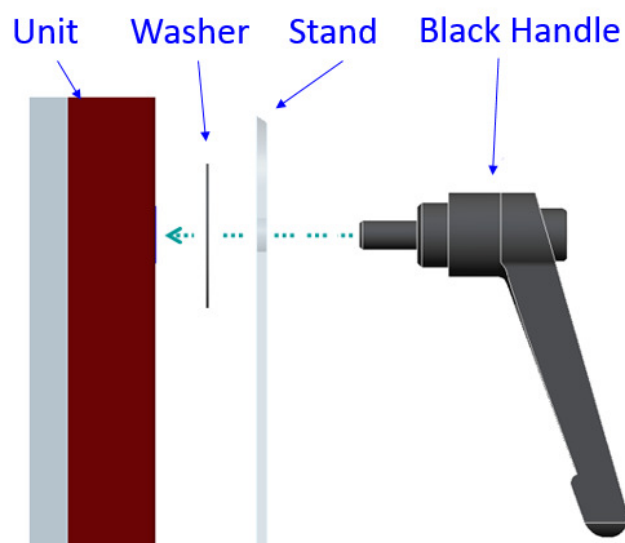

1. Step 3. Please tighten the black handle in a clockwise direction.

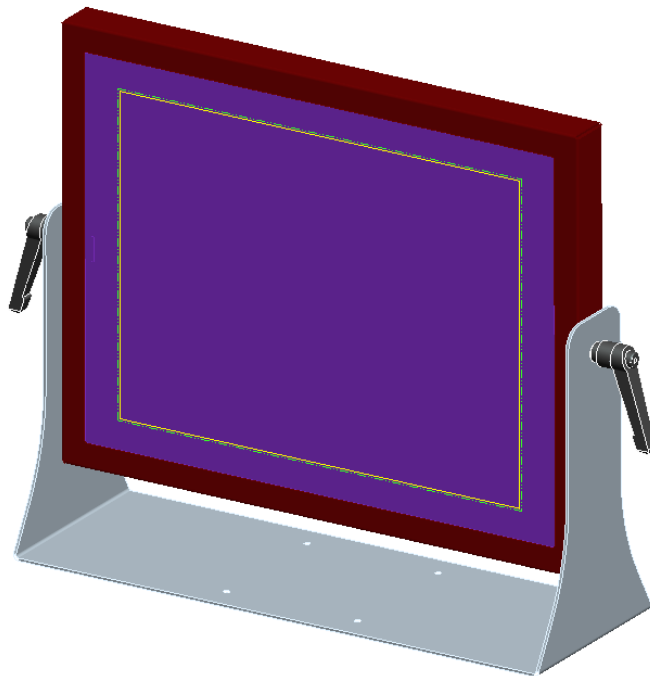
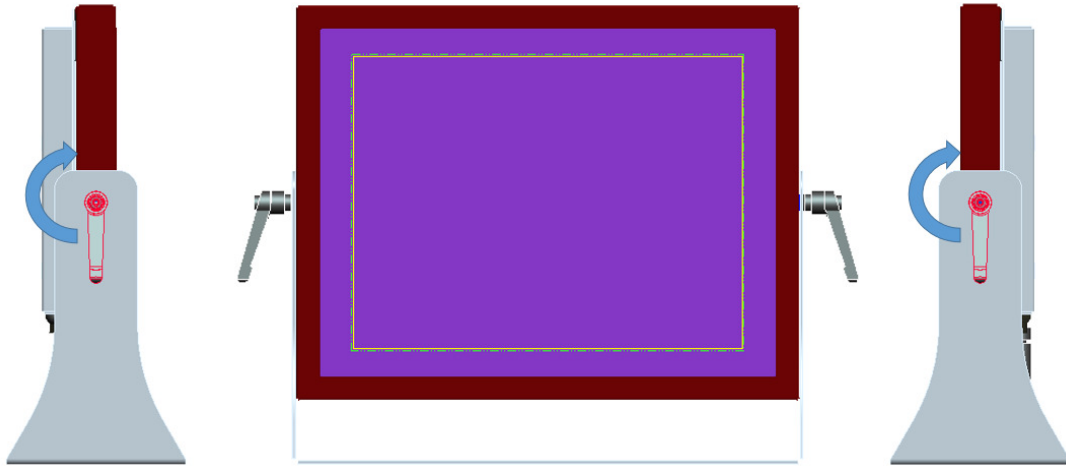

Wall Mount Stand Assemble Instruction

Step 1. Please check out the following parts before assemble.

No.	Item	Quantity
1	Wall Mount Stand	1
2	Black Silicone Washer	2
3	Black Handle	2

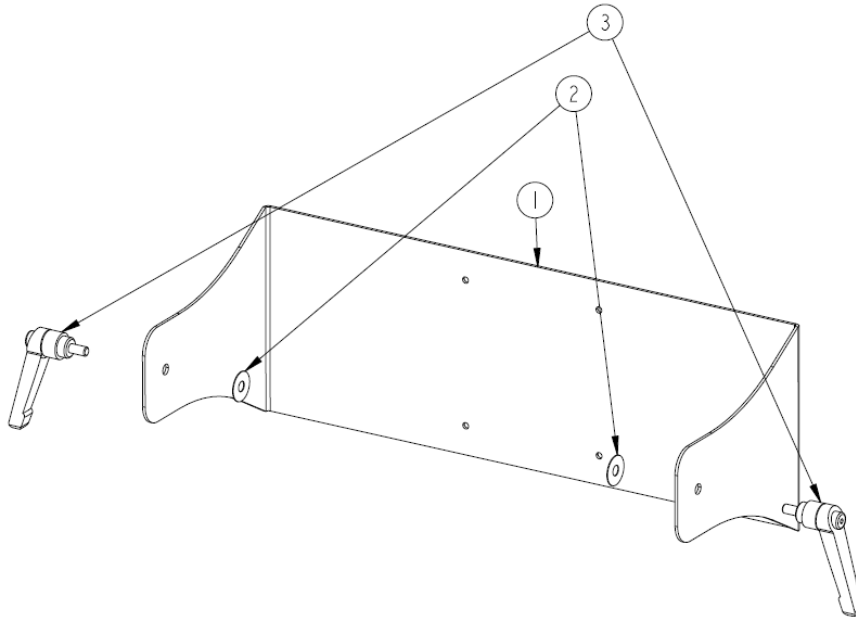

Step 2. Please follow the picture diagrams to assemble.

Explode View

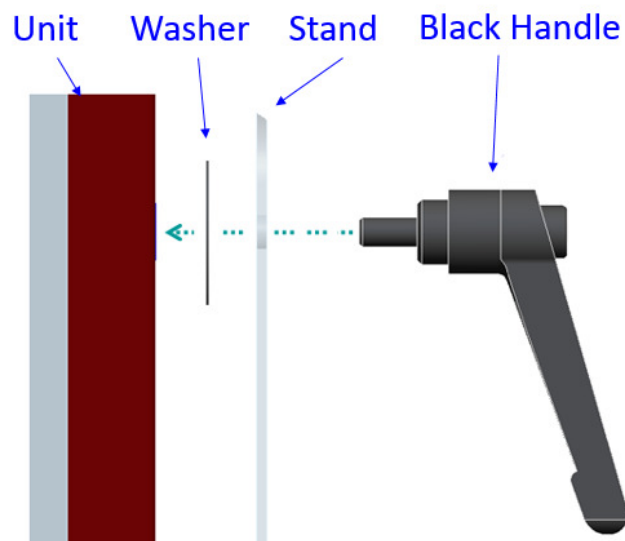

Step 3. Please tighten the black handle in a clockwise direction.

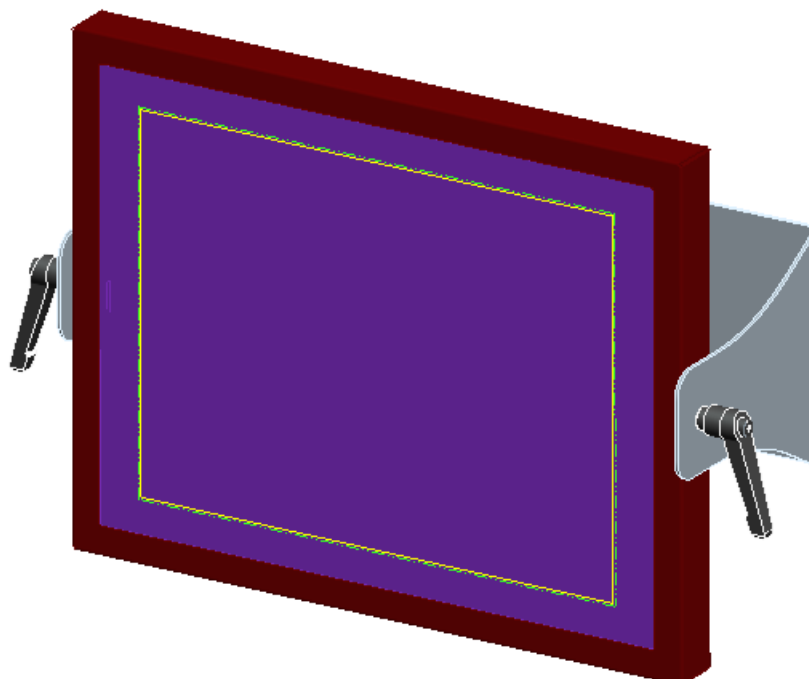
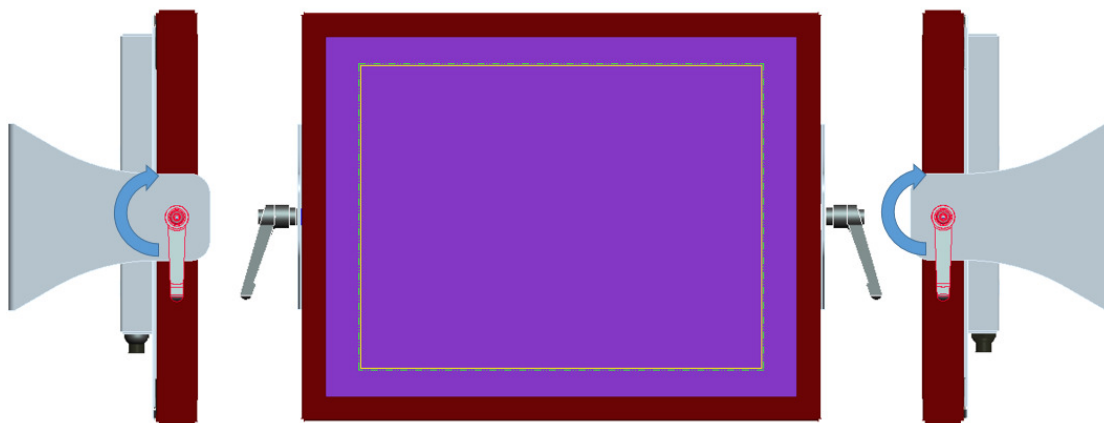

System View

WTP-8B66-15 Outline Drawing

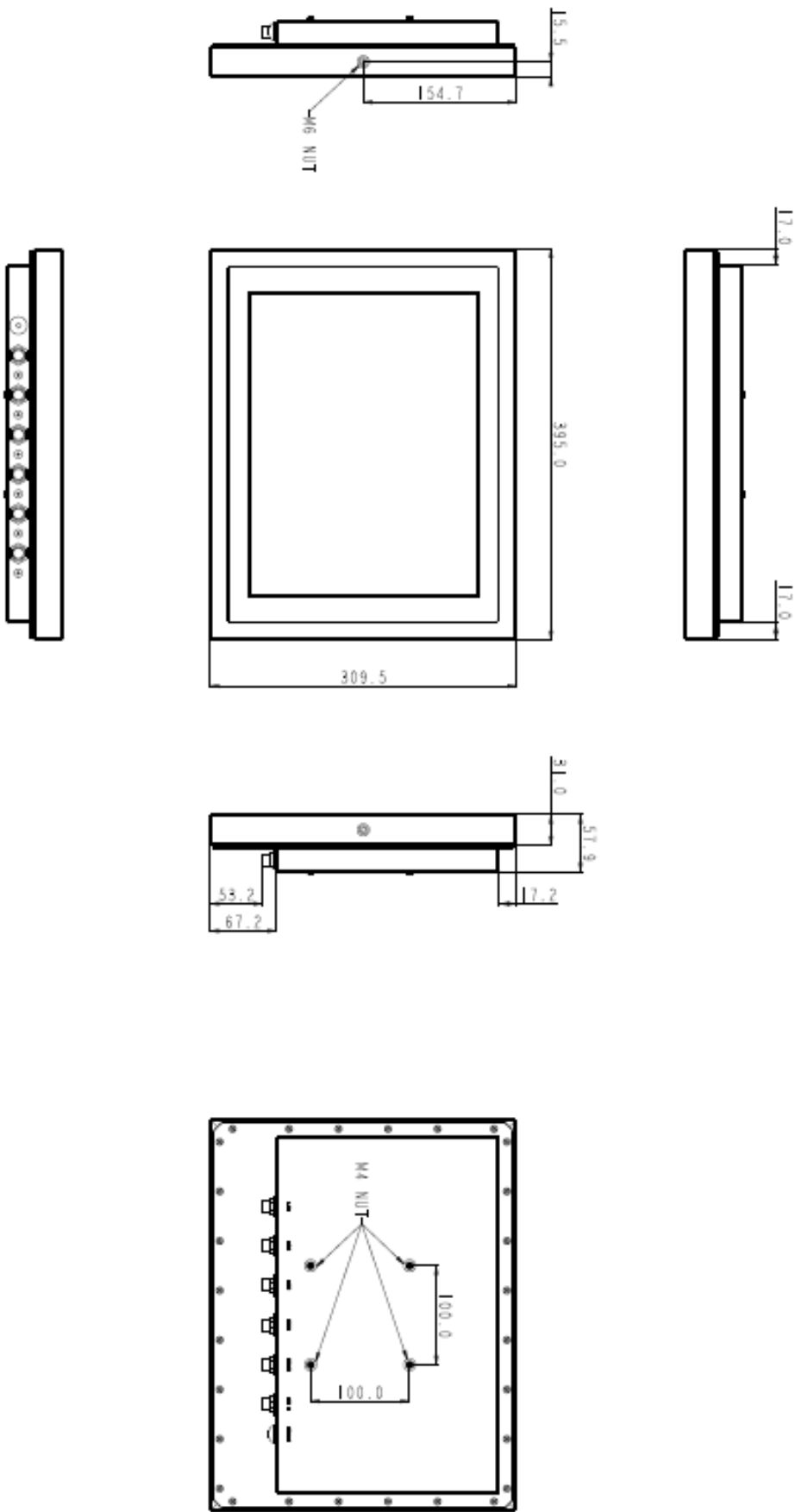

WTP-8B66-19 Outline Drawing

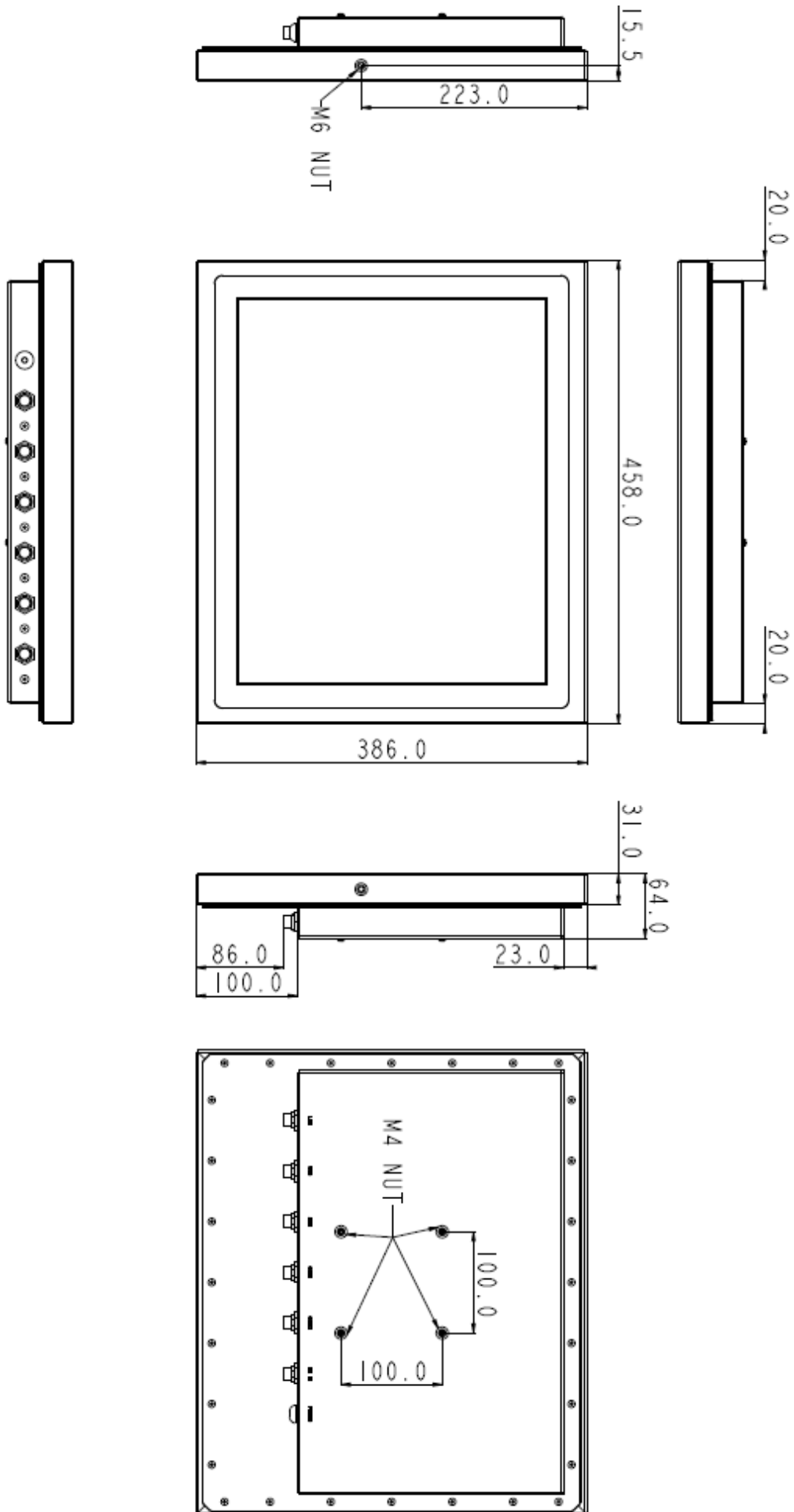

WTP-8B66-22 Outline Drawing

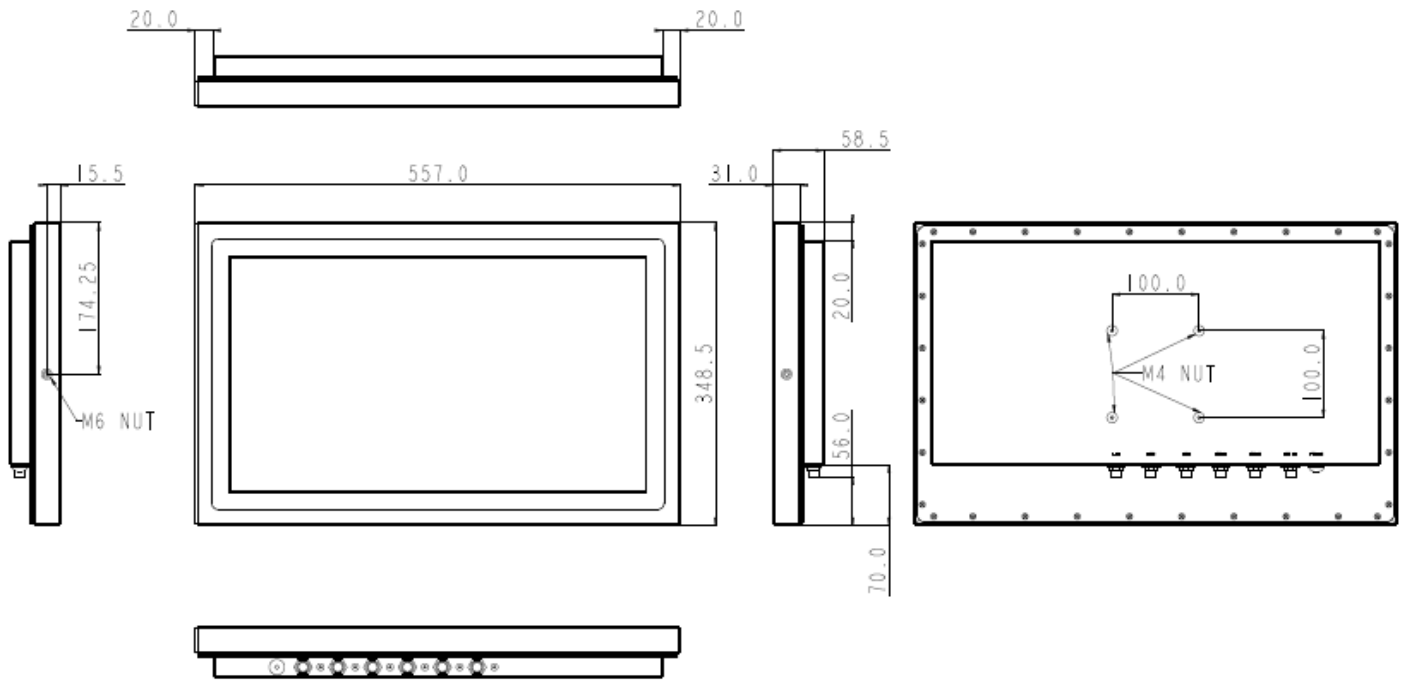

Setting up the System

The following is a summary of the steps in setting up the system for use.

CAUTION: Make sure that power to the system and each of the devices to be connected is switched OFF before plugging in the connectors.

1. Make any required external connections such as the keyboard, and mouse.
2. Plug the appropriate end of the power cord into the power connector of the system. Then plug the other end of the power cord to an electrical outlet.
3. Press the power switch of the system to turn on the system's power.
4. If necessary, run the BIOS SETUP program to configure the system (see Chapter 3).
5. Install the software drivers if necessary.

Installing System Software

Recent releases of operating systems from major vendors include setup programs, which load automatically and guide you through hard disk preparation and operating system installation. The guidelines below will help you determine the steps necessary to install your operating system on the Panel PC hard drive.

NOTE: Some distributors and system integrators may have already pre-installed system software prior to shipment of your Panel PC.

Installing software requires an installed HDD. Software can be loaded in the WTP-8B66 Panel PC using any of below methods:

Method 1: Use the Ethernet

You can use the Ethernet port to download software from the net to the HDD that has been pre-installed in WTP-8B66 Panel PC

Method 2: Use the COM Port

By connecting another PC to the WTP-8B66 Panel PC with an appropriate cable, you can use transmission software to transmit Operation System Software to the HDD that has been pre-installed in the WTP-8B66 Panel PC.

Method 3: Use a External CD-ROM

In order to boot up system from USB-CD/DVD drive, please connect USB-CD/DVD drive, turn on computer power, keep on pressing "F11" key, go into BIOS quick boot menu, select "USB-CD ROM", WAIT FOR 20 SECONDS, then press enter, system OS will boot up from USB-CD/DVD drive directly

Then you can use the external CD-ROM to transmit the software to the HDD that has been pre-installed in the WTP-8B66 Panel PC

Installing the Drivers

After installing your system software, you will be able to set up the LAN, VGA, Audio and USB functions. All drivers are stored in a CD disc, which can be found in your accessory pack.

The various drivers and utilities in the disc have their own text files that help users install the drivers and understand their functions.

Follow the sequence below to install the drivers:

- Step 1 – Install Intel® INF Driver
- Step 2 – Install Intel® VGA Driver
- Step 3 – Install Intel® LAN Driver
- Step 4 – Install Audio Driver

Step 1 – Install Intel® INF Driver

1. Open file of **chipset**
2. Click on the **setup.exe**
3. Follow the instructions that the window shows
4. The system will help you install the driver automatically
5. Reboot system

Step 2 – Install Intel® VGA Driver

1. Open file of **VGA**
2. Select the OS folder your system is
3. Click on the **.exe** file located in the OS folder
4. Follow the instructions that the window shows
5. The system will help you install the driver automatically
6. Reboot system

Step 3 – Install Intel® LAN Driver

1. Open file of **LAN**
2. Click on the **setup.exe**
3. Follow the instructions that the window shows
4. The system will help you install the driver automatically
5. Reboot system

Step 4 – Install Audio Driver

1. Open file of **LAN**
2. Click on the **setup.exe**
3. Follow the instructions that the window shows
4. The system will help you install the driver automatically
5. Reboot system

BIOS Setup Information

BIOS Introduction

The AMI BIOS (Basic Input / Output System) installed in your computer system's ROM supports Intel processors. The BIOS provides critical low-level support for a standard device such as disk drives, serial ports and parallel ports. It also adds virus and password protection as well as special support for detailed fine-tuning of the chipset controlling the entire system.

BIOS Setup

The AMI BIOS provides a Setup utility program for specifying the system configurations and settings. The BIOS ROM of the system stores the Setup utility. When you turn on the computer, the AMI BIOS is immediately activated. Pressing the key immediately allows you to enter the Setup utility. If you are a little bit late pressing the key, POST (Power On Self Test) will continue with its test routines, thus preventing you from invoking the Setup. If you still wish to enter Setup, restart the system by pressing the "Reset" button or simultaneously pressing the <Ctrl>, <Alt> and <Delete> keys. You can also restart by turning the system Off and back On again. The following message will appear on the screen:

Press to Enter Setup

In general, you press the arrow keys to highlight items, <Enter> to select, the <PgUp> and <PgDn> keys to change entries, <F1> for help and <Esc> to quit.

When you enter the Setup utility, the Main Menu screen will appear on the screen. The Main Menu allows you to select from various setup functions and exit choices.

Main

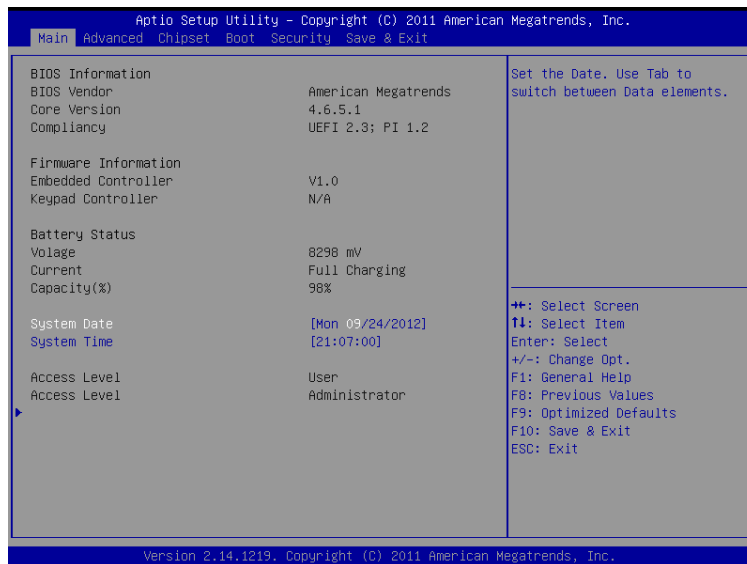

This section provides information on the BIOS information, Memory information, and Battery information

System Date

Set the system date. Use the <Tab> key to switch between data elements.

System Time

Set the system time. Use the <Tab> key to switch between time elements.

Advanced



Launch OpROM Support

Launch PXE OpROM

Enables or disables Boot Option for Legacy Network Devices.

Launch Storage OpROM

Enables or disables Boot Option for Legacy Mass Storage Devices with Option ROM.

PCI Subsystem Settings

PCI ROM Priority

In Case of multiple Option ROMs (Legacy and EFI Compatible), specifies what PCI Option ROM to launch.

PCI Latency Timer

Value to be programmed into PCI Latency Timer Register.

VGA Palette Snoop

Enables or disables VGA Palette Registers Snooping.

PERR# Generation

Enables or Disables PCI Device to Generate PERR#.

SERR# Generation

Enables or Disables PCI Device to Generate SERR#.

Relaxed Ordering

Enables or Disables PCI Express Device Relaxed Ordering.

Extended Tag

If ENABLED allows Device to use 8-bit Tag field as a requester.

No Snoop

Enables or Disables PCI Express Device No Snoop option.

Maximum Payload

Set Maximum Payload of PCI Express Device or allow System BIOS to select the value

Maximum Read Request

Set Maximum Read Request Size of PCI Express Device or allow System BIOS to select the value.

ASPM Support

Set the ASPM Level: Force L0 – Force all links to L0 State : AUTO – BIOS auto configure : DISABLE – Disables ASPM.

Extended Synch

If ENABLED allows generation of Extended Synchronization patterns.

ACPI Settings

Enables ACPI Auto Conf

Enables or Disables BIOS ACPI Auto Configuration.

Enable Hibernation

Enables or Disables System ability to Hibernate (OS/S4 Sleep State). This option may be not effective with some OS.

ACPI Sleep State

Select the highest ACPI sleep state the system will enter, when the SUSPEND button is pressed.

S5 RTC Wake Settings

Wake System with Fixed Time

Enables or disables system wake on alarm event. When enabled, the system will wake on the time specified.

Wake system with Dynamic Time

Enables or disables system wake on alarm event. When enabled, the system will wake on the current time+Increase minute(s).

CPU Configuration

Hyper-Threading

Enabled for Windows XP and Linux (OS optimized for Hyper-Threading Technology) and Disabled for other OS (OS optimized for Hyper-Threading Technology)

Core-Multi Processing

Enable or Disable Core-Multi Processing mode.

Execute Disable Bit

XD can prevent certain classes of malicious buffer overflow attacks when combined with a supporting OS (Windows Server 2003 SP1, Windows XP SP2, SuSE Linux 9.2, RedHat Enterprise 3 Update 3.)

Limit CPUID Maximum

Disabled for Windows XP.

IDE Configuration

ATA or IDE Configuration

Select ATA or IDE configuration.

Configure SATA AS

Select a configuration for SATA controller.

HDD Acoustic Power Ma

Option to enable or disable HDD Acoustic Power Management.

DiPM

Option to enable or disable DiPM

Intel IGD SWSCI OpRegion

DVMT Mode Select

Selects DVMT Mode used by Internal Graphics Device.

DVMT/FIXED Memory

Selects DVMT/FIXED Mode Memory size used by Internal Graphics Device.

IGD – Boot Type

Select the Video Device which will be activated during POST. This has no effect if external graphics present.

LCD Panel Type

Select LCD panel used by Internal Graphics Device by selecting the appropriate setup item.

Panel Scaling

Select the LCD panel scaling option used by the Internal Graphics Device.

GMCH BLC Control

Back Light Control Setting

BIA Control

Spread Spectrum clock

>>Hardware: Spread is controlled by chip;

>>Software: Spread is controlled by BIOS.

TV1 Standard

TV2 Standard

Active LFP

Select the Active LFP Configuration.

No LVDS:VBIOS does not enable LVDS.

INT-LVDS:VBIOS enables LVDS driver by Integrated encoder.

SDV0 LVDS:VBIOS enables LVDS driver by SDV0.

USB Configuration

Legacy USB Support

Allows USB devices to be used in MS-DOS.

EHCI Hand-off

This is a workaround for OSes without EHCI hand-off support. The EHCI ownership change should be claimed by EHCI driver.

USB transfer time-out

The time-out value for Control, Bulk, and Interrupt transfers.

Device reset time-out

USB mass storage device Start Unit command time-out.

Device power-up delay

Maximum time the device will take before it properly reports itself to the HOST Controller.

'Auto' uses default value: for a Root port it is 100 ms, for a Hub port the delay is taken from Hub descriptor.

F71869 Super IO Configuration

Serial Port 0 Configuration

Set Parameters of Serial Port 0 (COM A).

Serial Port 1 Configuration

Set Parameters of Serial Port 1 (COM B).

F71869 H/W Monitor

Monitor hardware status

Second Super IO Configuration

Serial Port 1 Configuration

Set Parameters of Serial Port 1 (COM C).

Serial Port 2 Configuration

Set Parameters of Serial Port 2 (COM D).

Serial Port 3 Configuration

Set Parameters of Serial Port 3 (COM E).

Serial Port 4 Configuration

Set Parameters of Serial Port 4 (COM F).

Serial Port Console Redirection

Serial Port Console Redirection.

Chipset

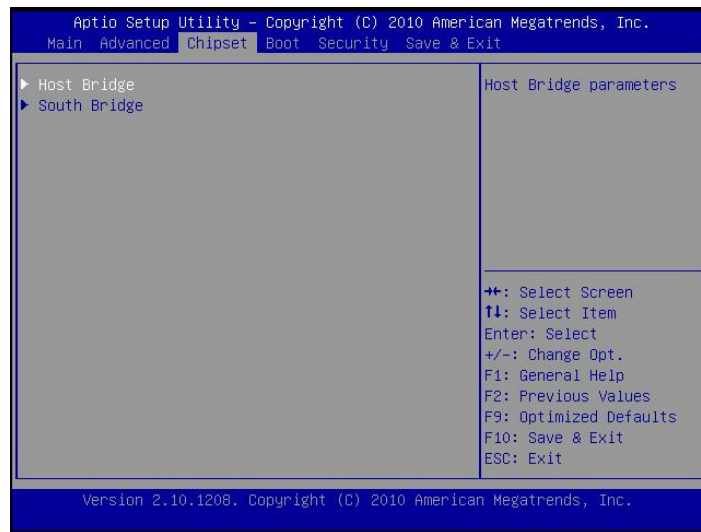

Host Bridge/South Bridge

This screen provides information on Host Bridge/South Bridge parameters.

Boot

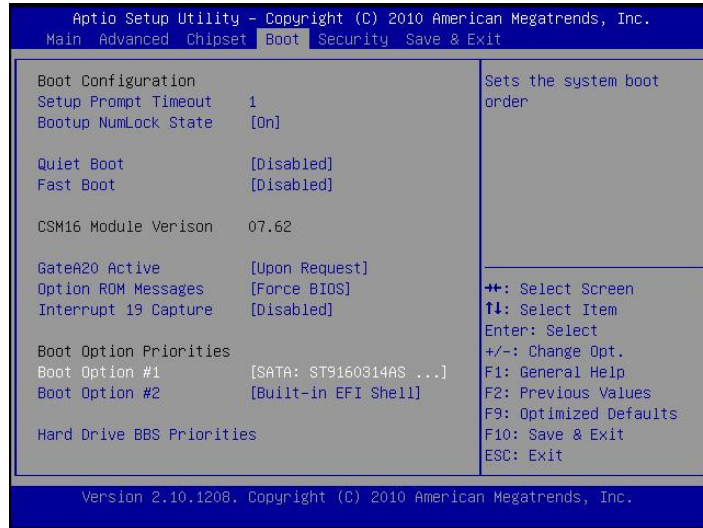

Setup Prompt Timeout

Number of seconds to wait for setup activation key. 65535(0xFFFF) means indefinite waiting.

Bootup Numlock State

Selects the keyboard NumLock state.

Quiet Boot

Allows you to determine whether to display the AMI Logo at system startup. **Disabled** displays normal POST message.

Fast Boot

Enables or disables the quick boot function to speed up the system boot-up process to shorten the waiting time for entering the operating system and to deliver greater efficiency for daily use.

GateA20 Active

This option is useful when any RT code is executed above 1MB.

Upon Request GA20 can be disabled using BIOS services. (Default)

Always Do not allow disabling GA20.

Option ROM Messages

Sets display made for option ROM.

Interrupt 19 Capture

Enables or disables Option ROMs to Trap Int 19.

Boot Option Priorities

Specifies the sequence of loading the operating system from the installed hard drives.

Security



Enables or disables the security chip. It is recommended that you use this function with the Administrator/User password.

Save & Exit

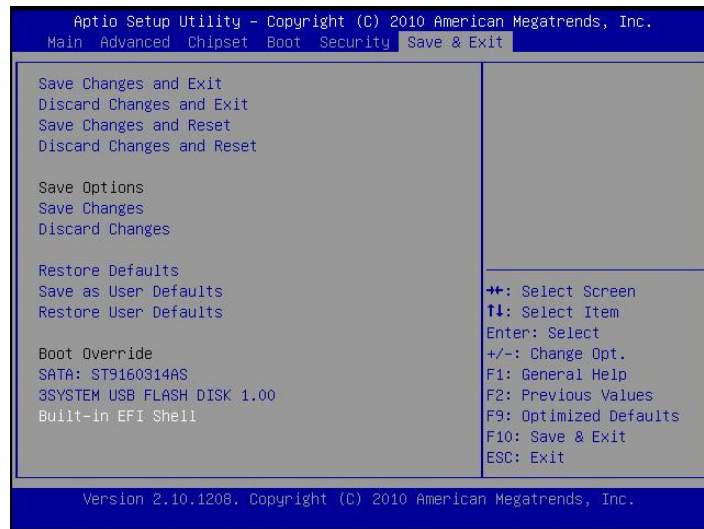

Save Changes and Exit

Exit system setup after saving the changes.

Discard Changes and Exit

Exit system setup without saving any changes.

Save Changes and Reset

Reset the system after saving the changes.

Discard Changes and Reset

Reset system setup without saving the changes.

Save Changes

Save the changes done so far to any of setup options.

Discard Changes

Discard the changes done so far to any of setup options.

Restore Defaults

Restore/load default values for all the setup options.

Save as User Defaults

Save the changes done so far as User Defaults.

Restore User Defaults

Restore the User Defaults to all the setup options.

EFIGUI_FLASH

Press <Enter> to execute the simple EFI GUI Flash Program.

Appendix

A. Jumper settings and Connectors

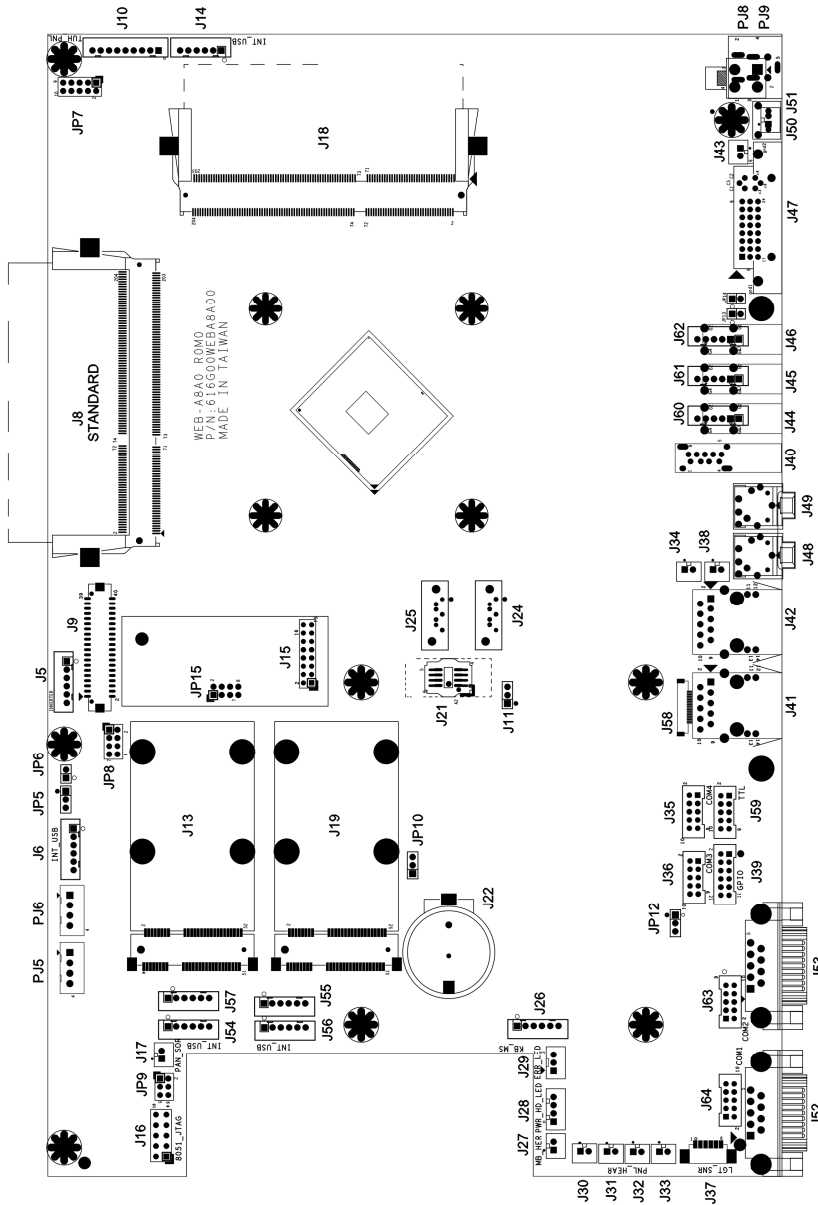

● JP5 – Backlight Type Selection

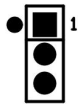

Description	Jumper Setting
Analog Inverter	1-2 (for 10")
PWM Inverter	2-3 (for 12"/15")

● **JP6 – Backlight control level Selection**



Description	Jumper Setting
+3.3V	1-2
+5V	<i>OPEN (default)</i>

● **JP7 – Touch Panel Type Selection**

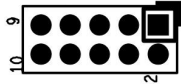

Description	Jumper Setting
<i>3M type</i>	<i>1-2, 3-4 (default)</i>
ELO type	5-6,7-8

● **JP8 – LVDS Power Selection**

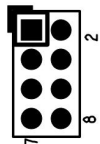

Description	Jumper Setting
+3.3VS(for 10"/12"/15")	<i>5-6, 7-8 (default)</i>
+5VS(for 17"/19")	1-2, 3-4

● **JP9 – Sensor Selection**

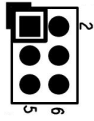

Description	Jumper Setting
<i>No Panel Sensor</i>	<i>1-2(default)</i>
No MB Sensor	3-4
Reserved	5-6

● **JP10 – CMOS Clear**

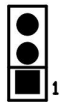

Description	Jumper Setting
<i>Normal Open</i>	<i>1-2 (default)</i>
CMOS Clear	2-3

● **JP11 – SATA / SATADOM Selection**

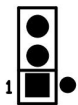

Description	Jumper Setting
<i>SATA</i>	<i>2-3(default)</i>
SATA DOM	1-2

● **JP12 – COM3 Power Selection**

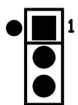

Description	Jumper Setting
+5VS	<i>2-3(default)</i>
+12VS	1-2

● **JP13,J14 –Y cable* Support both DVI+VGA**

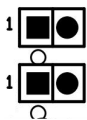

Description	JP13	JP14
<i>No support (default)</i>	<i>Open</i>	<i>Open</i>
Support	1-2	1-2

*Support Wincomm Y cable only.

● **JP15 –Panel Resolution Selection**

JP15 jumper setting				Panel Resolution	Color Depth
1-2	3-4	5-6	7-8		
0	0	0	0	800x600	6bit
0	0	0	1	1024x768	6bit
0	0	1	0	1024x768	8bit
0	0	1	1	1280x768	6bit
0	1	0	0	1280x800	6bit
0	1	0	1	1280x960	6bit
0	1	1	0	1280x1024	8bit
0	1	1	1	1366x768	6bit
1	0	0	0	1366x768	8bit
1	0	0	1	1440x900	8bit
1	0	1	0	1440x1050	8bit
1	0	1	1	1600x900	8bit
1	1	0	0	1680x1050	8bit
1	1	0	1	1600x1200	8bit
1	1	1	0	1920x1080	8bit
1	1	1	1	1920x1200	8bit

Connector Definition

● PJ5 /PJ6 – HDD Power Connector

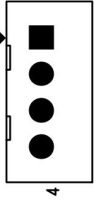

Pin #	Signal Description
1	+12VS
2	GND
3	GND
4	+5VS

● PJ8 – Power Jack

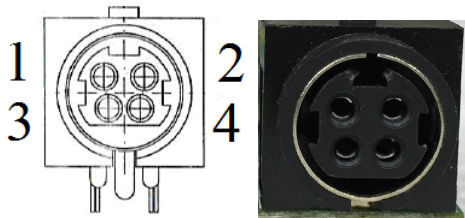

Pin #	Signal Description
1	DC In
2	DC In
3	GND
4	GND

● PJ9 – Power Input Connector

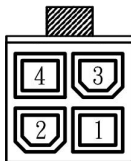

Pin #	Signal Description
1	GND
2	GND
3	DC In
4	DC In

● **J5 – LCD Inverter Wafer Header**

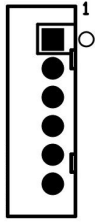

Pin #	Signal Description
1	+12VS
2	+12VS
3	Backlight Control
4	Backlight Enable
5	GND
6	GND

● **J6, J54, J56 – Internal USB 2.0 Pin Header**

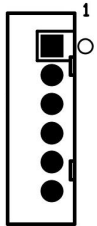

Pin #	Signal Description
1	+5VSB
2	+5VSB
3	Data -
4	Data +
5	GND
6	GND

● J9 – LVDS Interface

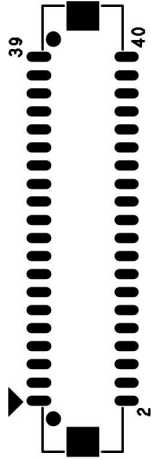

Pin #	Signal Description	Pin #	Signal Description
39	GND	40	GND
37	Ground	38	GND
35	A_TXD3+	36	B_TXD3+
33	A_TXD3-	34	B_TXD3-
31	GND	32	GND
29	A_CLK+	30	B_CLK+
27	A_CLK-	28	B_CLK-
25	GND	26	GND
23	A_TXD2+	24	B_TXD2+
21	A_TXD2-	22	B_TXD2-
19	GND	20	GND
17	A_TXD1+	18	B_TXD1+
15	A_TXD1-	16	B_TXD1-
13	GND	14	GND
11	A_TXD0+	12	B_TXD0+
9	A_TXD0-	10	B_TXD0-
7	GND	8	GND
5	GND	6	GND
3	+LVDS PWR	4	+LVDS PWR
1	+LVDS PWR	2	+LVDS PWR

● J10 – Resistance Touch Screen Interface

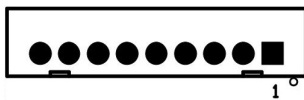

Pin #	Signal Description		
	8-wire	4-wire	5-wire
1	UL(X+)	UL(X+)	UL(X+)
2	UR(Y+)	UR(Y+)	UR(Y+)
3	N/A	N/A	PROBE
4	LR(X-)	LR(X-)	LR(X-)
5	LL(Y-)	LL(Y-)	LL(Y-)
6	X+_DRIVE	N/A	N/A

7	Y+_DRIVE	N/A	N/A
8	X-_DRIVE	N/A	N/A
9	Y-_DRIVE	N/A	N/A

● **J13 / J19 – Mini PCI Express Socket**

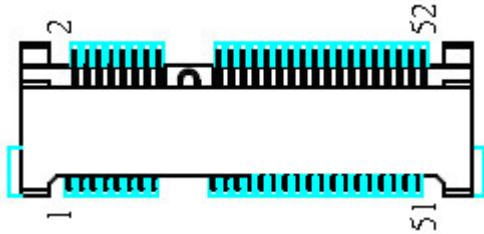

● **J14 –P-CAP Touch screen interface***

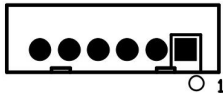

Pin #	Signal Description
1	+5VSB
2	+5VSB
3	Data -
4	Data +
5	Ground
6	Ground

* Res(J10) with P-CAP(J14) select one

● **J15 –TPM / ID-394**

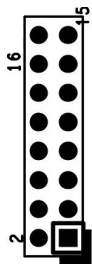

Pin #	Signal Description	Pin #	Signal Description
16	+3.3VSB	15	SUS_STAT#
14	SMB DATA	13	GND
12	SMB CLK	11	Debug CLK
10	CLKRUN#	9	LPC Frame#
8	+5VSB	7	LPC AD3
6	+3.3VS	5	LPC AD2
4	SERIRQ	3	LPC AD1
2	PLT reset#	1	LPC AD0

● **J16 – For JTAG**

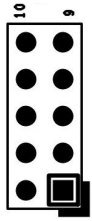

Pin #	Signal Description	Pin #	Signal Description
10	Reserved	9	GND
8	Reserved	7	+3.3V
6	Reserved	5	+3.3V
4	C2D	3	GND
2	GND	1	+3.3V

● **J17 – Panel Temp Sensor Connector**



Pin #	Signal Description
1	PANEL_SENSOR
2	GND

● **J21 – BIOS Socket**

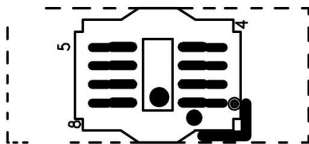

● **J22 – Battery Socket**

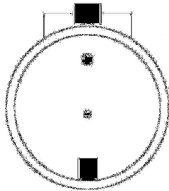

● **J24 – Standard SATA / SATA DOM Interface**

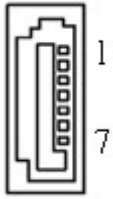

Pin #	Signal Description
1	Ground
2	Tx+
3	Tx-
4	Ground
5	Rx-
6	Rx+
7	Ground / +5VS

● **J25 – Standard SATA Interface**



Pin #	Signal Description
1	Ground
2	Tx+
3	Tx-
4	Ground
5	Rx-
6	Rx+
7	Ground

● **J26 – PS2 KB/MS**

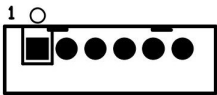

Pin #	Signal Description
1	KBDATA
2	MSDATA
3	Ground
4	+5VSB
5	KBCLK
6	MSCLK

● **J27 – MB Heater Connector**



Pin #	Signal Description
2	GND
1	+12VSB

● **J28 – Power / HDD LED**

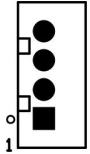

Pin #	Signal Description
4	PWR_LED#
3	+3.3VSB
2	+3.3VSB
1	SATA_LED#

● **J29 – Heater Error / Heating LEDs**

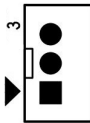

Pin #	Signal Description
3	+3.3V
2	HEATER_LED#
1	ERROR_LED#

● **J30, J31, J32, J33 – Panel Heater Connector**



Pin #	Signal Description
1	+12VSB
2	GND

● **J34, J38 – RIGHT / LEFT CH for Speaker.**



Pin #	Signal Description	
	J34 (RIGHT CH)	J38 (LEFT CH)
1	ROUT+	LOUT+

2	ROUT-	LOUT-
---	-------	-------

J35 – Internal COM4 Serial Port

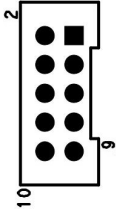

Pin #	Signal Description	Pin #	Signal Description
2	232_DSR#	1	232_DCD#
4	232_RTS#	3	232_SIN
6	232_CTS#	5	232_SOUT
8	232_RI#	7	232_DTR#
10	+5VS	9	GND

J36 – Internal COM3 Serial Port

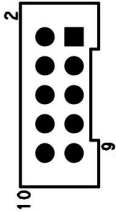

Pin #	Signal Description	Pin #	Signal Description
2	232_DSR#	1	232_DCD#
4	232_RTS#	3	232_SIN
6	232_CTS#	5	232_SOUT
8	232_RI#	7	232_DTR#
10	+5VS/+12VS	9	GND

J37 – Light Sensor Connect



Pin #	Signal Description
1	+3.3V
2	NC
3	Ground
4	SCL1
5	NC
6	SDA1

J39 – GPIO Connect

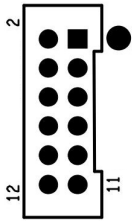

Pin #	Signal Description	Pin #	Signal Description
2	GEN_GPI1	1	GEN_GPO1
4	GEN_GPI2	3	GEN_GPO2
6	GEN_GPI3	5	GEN_GPO3
8	GEN_GPI4	7	GEN_GPO4
10	+5V	9	+5V
12	GND	11	GND

J40 – External USB 3.0 Port

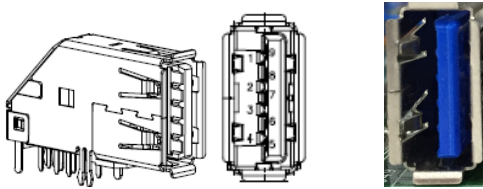

J41 / J42 – External RJ45 Ethernet Port

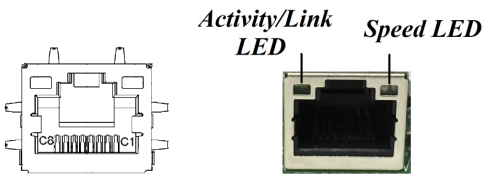

Activity/Link LED

Status	Description
OFF	No Link
Blinking	Data Activity
ON	Link

Speed LED

Status	Description
OFF	10 Mbps
Green	100 Mbps
Orange	1 Gbps

J43 – Power Switch connect



Pin #	Signal Description
1	Power ON
2	GND

● **J44,J45,J46 – External USB 2.0 Port**

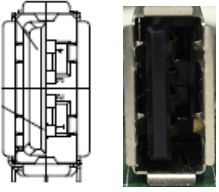

Pin #	Signal Description
1	+5V
2	USB_D-
3	USB_D+
4	GND

● **J47 – External DVI-I Connector**

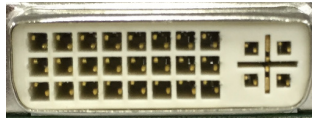
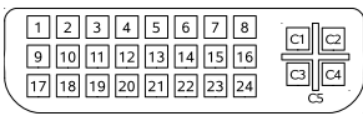

● **J48 / J49 – External Audio Phone Jack**

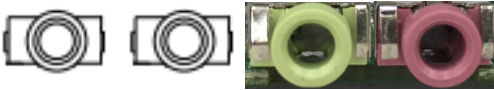

Audio Jack	Signal Description
J48	Line Out (stereo) Green
J49	Microphone (stereo) Pink

● **J50 – Reset Button**

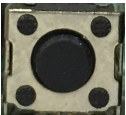

Pin #	Signal Description
1	SYS_RESET#
2	GND
3	GND
4	GND

● **J51 – Reset connector**



Pin #	Signal Description
1	SYS_RESET#
2	GND

J52 – External COM1 Connector

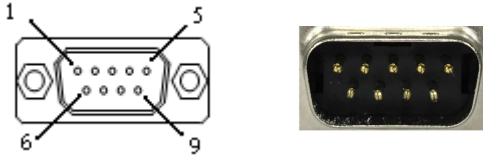

Pin #	Signal Description		
	RS-232	RS-422	RS-485
1	DCD	TX D-	DATA-
2	RXD	TX D+	DATA+
3	TXD	RX D+	--
4	DTR	RX D-	--
5	GND	--	--
6	DSR	--	--
7	RTS	--	--
8	CTS	--	--
9	RI#	--	--

J53 – External COM2 Connector

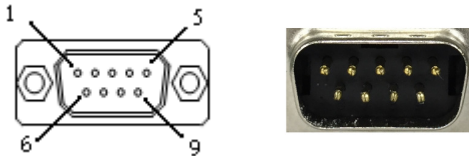

Pin #	Signal Description	Pin #	Signal Description
1	DCD	2	RXD
3	TXD	4	DTR
5	GND	6	DSR
7	RTS	8	CTS
9	RI#	10	--

J54/J55*/J56/J57* – Internal USB 2.0 Pin Header

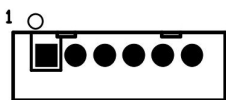

Pin #	Signal Description
1	+5VSB
2	+5VSB
3	Data -
4	Data +
5	GND
6	GND

*J55/J57 reserve for Mini PCIE x1 share.

J60/J61/J62 – Internal USB 2.0 Pin Header

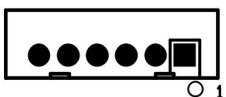

Pin #	Signal Description
1	+5VSB
2	+5VSB
3	Data -
4	Data +
5	GND
6	GND

*Co-lay with external USB port (J44, J45 and J46).

● J58 – External PoE Slot (Option)

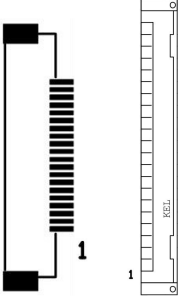

Pin #	Signal Description
1	LAN0_MDI0_P
2	LAN0_MDI0_N
3	GND
4	GND
5	LAN0_MDI1_P
6	LAN0_MDI1_N
7	GND
8	GND
9	GND
10	GND
11	GND
12	GND
13	GND
14	GND
15	LAN0_MDI2_P
16	LAN0_MDI2_N
17	GND
18	GND
19	LAN0_MDI3_P
20	LAN0_MDI3_N

B. Touch Lock AP User's Manual

1. API Prerequisites

Obtaining the AP and Related Documentation

This Touch Lock Tools Application Program (AP) and related documentation are available for whom has signed and returned a copy of the AP Licensing Agreement to Wincomm. Contact Wincomm account manager if you require a copy of the software.

Touch Lock Tools AP Requirement

This Touch Lock Tools AP is supported under the following operating systems and Wincomm product platforms:

Operating system: Microsoft™ Windows XP pro 32bit / 64bit, Microsoft™ Windows XP embedded 32bit / 64bit, Microsoft™ Windows 7 pro 32bit / 64bit, Microsoft™ Windows 7 embedded standard 32bit / 64bit.

Product platforms: WLP-7B20.

2. The Touch Lock Tools AP Program

2.1 Overview

The following instructions assume that you have obtained the Touch Lock Tools AP software, and have a working knowledge of the operating system on which you are installing the AP files. If you are in any doubt about the installation procedures, please contact your account manager to get the help.

2.2 API use procedure

2.2.1 If Touch Lock Tools is enable, touch panel will lock by set unit times (default: 20 seconds).

2.3 Run Program

2.3.1 Confirm that the system has been installed Microsoft Visual C++ 2008 Redistributable and Microsoft .NET Framework 2.0.

2.3.2 Run "Touch_Lock_Tools.exe" to running program as follow:

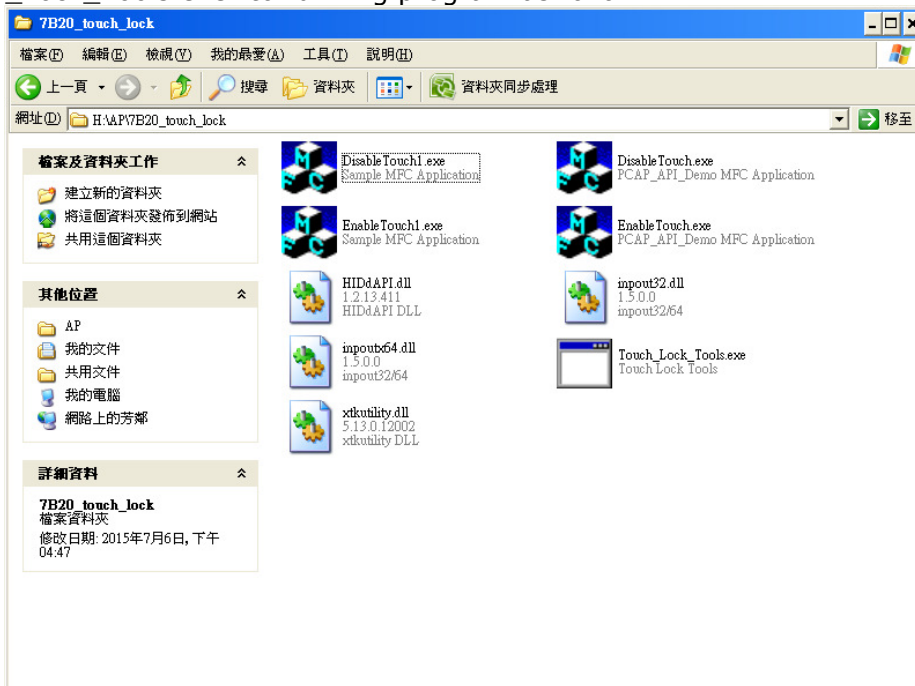

2.3.3 You can see the Touch Lock Tools form and min keyboard as below.



2.3.4 You can change touch lock timer (range 1-100 / 1-99 means 1-99 seconds / 100 means always lock). By set value in textbox and click "Set" button. If setting success, it will show message as follow.



If setting timer value error, it will show error message as follow.

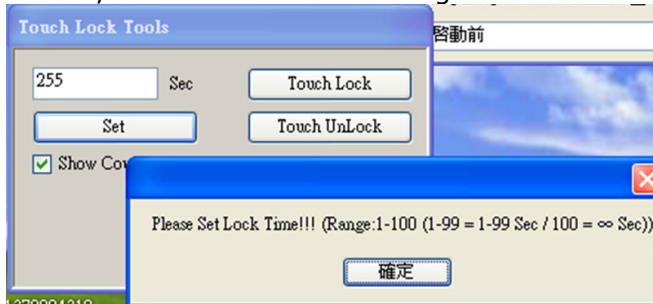

2.3.5 If touch lock is enable, you will see the timer in the lower right corner of the screen, and icon in task bar will become red .

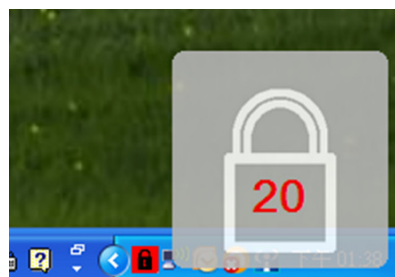

2.3.6 If timer countdown to zero, touch will unlock automatically, and icon in task bar will become green.

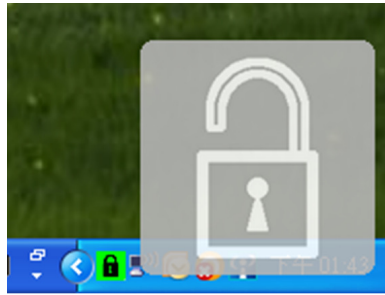

2.3.7 If you don't want to see the counter, you can uncheck the show counter option.



2.3.8 When you click "Minimize" button, the form will concealed below Task Bar.

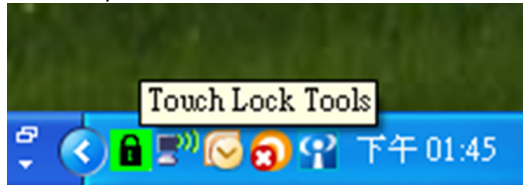

2.3.9 When you click "Exit" button, program will disable WDT and close.

3. Getting Help

If assistance is required when running the AP, please contact your account manager.